

ARKETIPO / DIVANI-EN

BACK PACK

designed by Giuseppe Vigano' 2022



STRUCTURE (seats and backs):wood.

SEAT UPHOLSTERY:multi-density expanded polyurethane foam (D30+Memory foam) covered with synthetic lining 230gr.

BACK UPHOLSTERY:multi-density expanded polyurethane foam (D30+D25) covered with synthetic lining 230gr.

BACKREST ROLL UPHOLSTERY:expanded polyurethane covered with coupled synthetic lining 180gr.

BACK CUSHION UPHOLSTERY (7110862): outer side in downproof 100% Gabardine 30/20 cotton cover; filling in goose feathers and polyester fibres.

BACK CUSHION UPHOLSTERY (7110863): outer side in downproof 100% Gabardine 30/20 cotton cover; filling in 100% goose feathers, inner core in expanded polyurethane (T18S).

SEAT HEIGHT:37 cm.

BACK HEIGHT: 66 cm.

FEET: Pouf: plastic, h. 3 cm - Back: metal varnished micaceous brown, h. 1,5 cm.

SMALL TABLE: wood veneered in eucalyptus or zebrano.

Seat unit A1

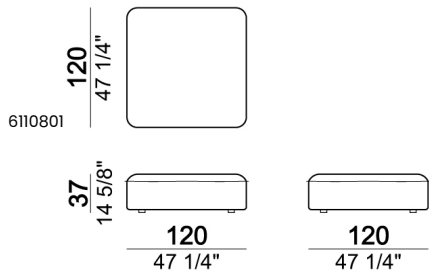

Seat unit A2

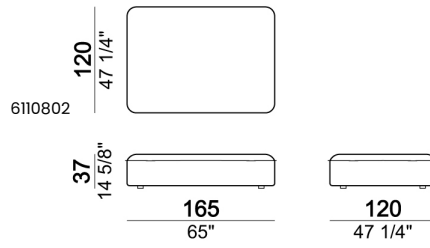

Seat unit A3

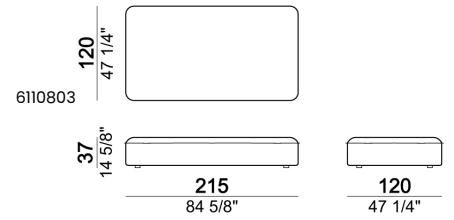

Seat unit B1

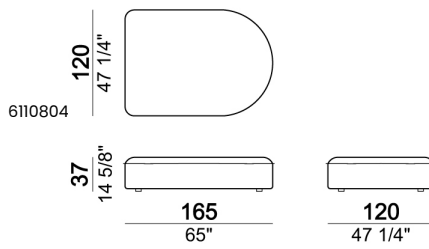

Seat unit C1

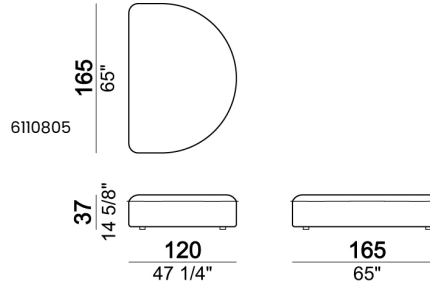

Back S1

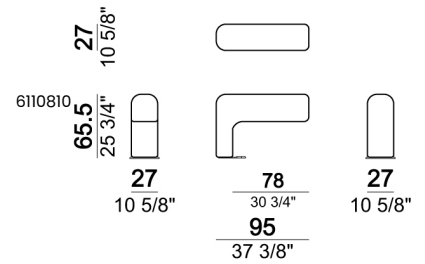

Back S2

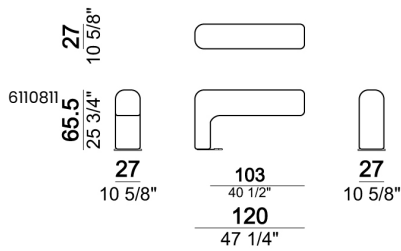

Back S3

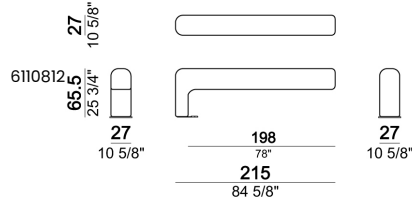

Back cushion

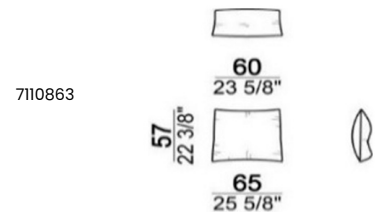
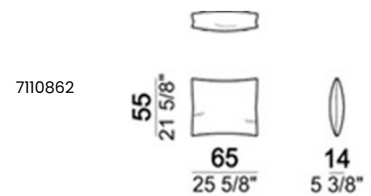

Roll for arm or back cushion support

7110865

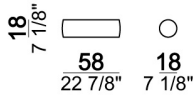

Small table

57108

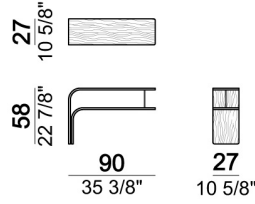

Composition 'A' (seat unit A3 + no.2 backs S2 + no.2 back cushions + small table).

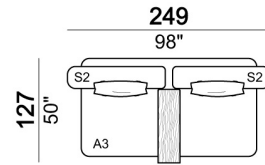

Composition 'B' (seat unit B1 + seat unit C1 + no.2 backs S2 + roll + no. 2 back cushions + small table).

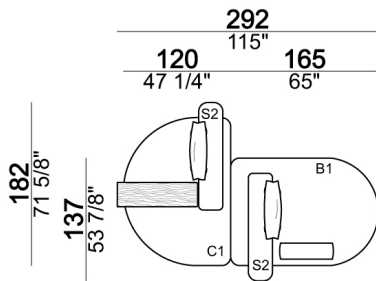

Composition 'C' (seat unit A2 + seat unit B1 + seat unit C1 + no.2 backs S2 + no.1 back S1 + roll + no.3 back cushions + small table).

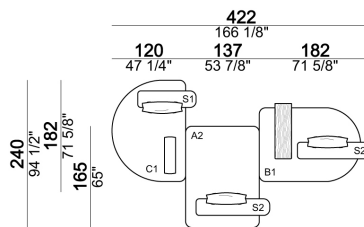

Composition 'D' (seat unit A2 + seat unit B1 + no.2 backs S2 + no.2 back cushions + roll).

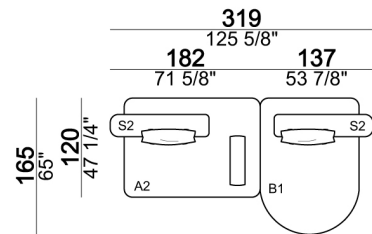

Composition 'E' (seat unit A3 + no.1 back S3 + no.2 back cushions + roll).

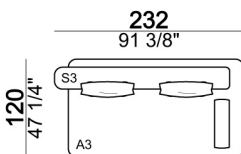

Composition 'F' (no. 2 seat units C1 + no.1 back S2 + no.2 back cushions + roll).

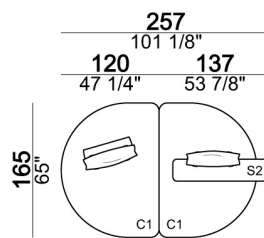

Composition 'G' (seat unit A3 + seat unit B1 + seat unit C1 + no.2 backs S2 + no.1 back S3 + no.3 back cushions + no. 2 rolls + small table).

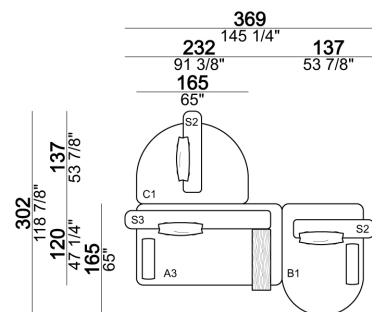

Composition 'H' (no.2 seat units A2 + no.2 seat units B1 + no.2 backs S2 +no.1 back S3 + no.5 back cushions + roll).

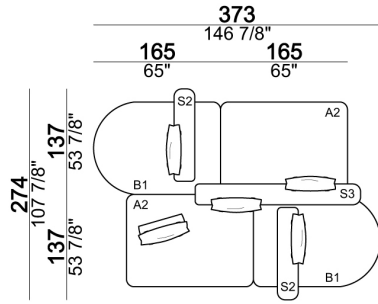

Composition 'L' (seat unit A3 + seat unit B1 + 1 back S2 + 1 back S3 + 2 back cushions 7110862 + 1 back cushion 7110863 + 1 roll + small table).

